

AUTOMATIC SCREW PRESENTER





PRODUCTIVE SOLUTIONS

As an industrial process expert, we help you meet your challenges.

Productivity, safety, quality, industry 4.0 are themes on which we can offer you our expertise and our solutions. Whether in the field of assembly technology, machining or welding, our dedicated and specialised teams accompany your progress and recommend solutions and equipment to reach performance levels in line with your industrial strategy.



Certified quality

From design to commissioning, DOGA guarantees the quality of this equipments and services according to ISO 9001: 2015 certification.

5 reasons to trust us



Expertise

Our field experts propose you solutions adapted to your environment and specific needs.



Innovation

By developing the products and the services of tomorrow, we offer you new perspectives or prospects.



Performance

Our high added value solutions improve your performances and guarantee the final quality of the production.



Commitment

Aware of your objectives, we commit ourselves to helping you to reach them.



Reliability

Our organization which has been ISO 9001 certified since 1996, is the guarantee of your satisfaction.



ASSEMBLY
TECHNOLOGY

As world class assembly technology player, we manufacture and market equipments and solutions for the assembly industry which contribute to the improvement of your manufacturing quality and productivity.

Our assembly, ergonomics and traceability solutions contribute to enhancing your productivity, controlling your process quality and meet the requirements of industry 4.0.

We offer products designed to last and high value-added services by relying on our teams know-how and expertise : design, production, installation, start-up, training and maintenance. We support you locally thanks to our worldwide presence through our subsidiaries and our specialized distribution network.



Support: +49 7361 8049950

www.dogatec.de

SUMMARY

AUTOMATIC SCREW PRESENTER

Pages

▶ 4	AUTOMATIC SCREW PRESENTERS WITH HORIZONTAL RAIL SYSTEM
▶ 7	NJ SERIES
▶ 9	NJL SERIES
▶ 11	NJC SERIES
▶ 13	NSB SERIES
▶ 15	NSBI SERIES
▶ 17	SS SERIES
▶ 19	OM-26M SERIES
▶ 21	NJR SERIES
▶ 23	NJRL SERIES
▶ 25	NSR SERIES
▶ 27	NSRI SERIES
▶ 29	OM-26R SERIES
▶ 31	FM-36 SERIES
▶ 33	ADDITIONAL HOPPERS
▶ 37	SERVICES AND ACCESSORIES
▶ 38	OUR SERVICES

AUTOMATIC SCREW PRESENTERS WITH HORIZONTAL RAIL SYSTEM

The gripping of small screws is delicate or even difficult.

- ▶ Screw dispensers present the screws to the user, which frees the operator's hand and facilitates the assembly of your application.
- ▶ They support a wide range of screw materials and shapes.
- ▶ They contribute to the efficiency of your production chain.
- ▶ The interchangeability of rails allows flexibility in your production lines.

BENEFITS

The gripping of small screws is delicate or even difficult

The horizontal rail allows the smooth presentation of many types of special screws including those with washers and short lengths under the head.



Horizontal rail provides a stable assembly and an orderly distribution of screws

Unlike gravity-based mechanisms, this one uses vibration to transport screws in a horizontal rail, eliminating problems such as overlapping or clogging and allowing a stable presentation, even for screws with washers.

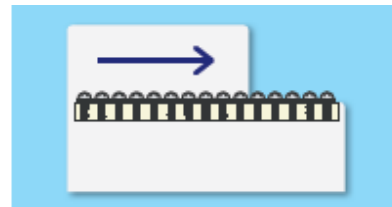

⊕ Adapts to different screw diameters by simple rail replacement

The same model supports screw diameter by simply changing the rail. Some models support up to 8 screw diameters for a single unit.



SCREW GRIPPING METHOD

For manual and magnetic picking up of the screw

Favour manually operated dispensers (NJ / NSB / NSBI / SS / OM-26M) because the screws are presented one by one at the bottom of a funnel-shaped blade guide where they are attached to the magnetic screwdriver bit without any effort.



For screw picking up by vacuum or for use in automatic stations

Favour presenter (NJR / NSR / NSRI / OM-26R)

The screws are presented one by one in a perfectly flat and unobstructed space for gripping at the end of the suction barrel or without any hindrance.

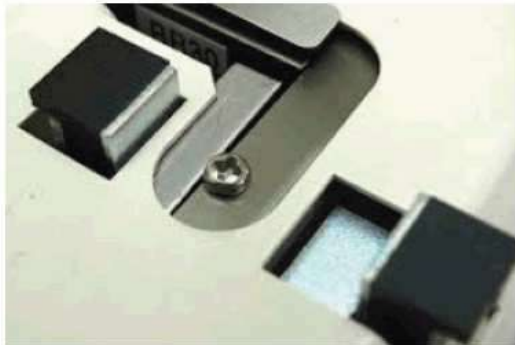

LIST OF MODELS

To choose the model that corresponds to your application:

- 1 - Select the use (Use on manual, automatic or by quantity)
- 2 - Select the screw diameter of your application
- 3 - Select the model adapted to the length of your screw
- 4 - Select the model adapted to the material of your screw

Use	Serie	Model	Screw diameter												Supported screw maximum under-head length	Supported materials
			1,0	1,2	1,4	1,7	2,0	2,3	2,6	3,0	3,5	4,0	5,0	6,0		
Manual	NJ	NJ-23					■	■	■	■					18 mm	Ferrous/non-ferrous (irrespective of material)
		NJC-23					■	■	■	■					25 mm	
		NJL-23					■	■	■	■					18 mm	
		NJ-45									■	■	■		25 mm	
		NJC-45									■	■	■		20 mm	
		NJL-45									■	■	■		16 mm	
	NSB	NSB	■	■	■	■	■	■	■	■					20 mm	
		NSBC	■	■	■	■	■	■	■	■						
	NSBI	NSBI	■	■	■	■	■	■	■	■						
	SS	SS-12	■	■	■	■	■									
		SS-23						■	■	■						
OM-26M	OM-26M					■	■	■	■	■	■	■	25 mm	Iron only Stainless : No (Uses magnet)		
Automatic	NJR	NJR-23					■	■	■	■				18 mm	Ferrous/non-ferrous (irrespective of material)	
		NJRL-23					■	■	■	■				25 mm		
		NJR-45									■	■	■	18 mm		
		NJRL-45									■	■	■	25 mm		
	NSR	NSR	■	■	■	■	■	■	■	■				20 mm		
	NSRI	NSRI	■	■	■	■	■	■	■	■						
	OM-26R	OM-26R					■	■	■	■	■	■	■	25 mm	Iron only Stainless : No (Uses magnet)	
Fixed quantity pick up	FM-36	FM-36								■	■	■	■	25 mm	Ferrous/non-ferrous (irrespective of material)	

NJ SERIE



Take out type

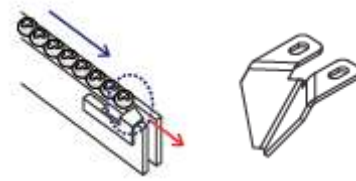

- ▶ Accepts screw diameters up to 5 mm.
- ▶ Large autonomy the hopper has a capacity of 150cc. increased by using an additional hopper.

Suitable screws

Model	Suitable Ø screw body (mm)	Suitable Ø screw head (mm)	Suitable H screw (mm)	Suitable washer Ø (mm)	Screw shaft length (mm)
NJ-2320	2 (1,8 to 2,1)	3 to 3,5	0,5 to 5,5	3 to 8	2,6 to 18
NJ-2323	2,3 (2,1 to 2,4)	3 to 4	0,5 to 5,5	3 to 8	2,9 to 18
NJ-2326	2,6 (2,4 to 2,7)	3,6 to 4,5	0,5 to 5,5	3 to 8	3,2 to 18
NJ-2330	3 (2,8 to 3,1)	4 to 5,5	0,5 to 5,5	4 to 8	3,6 to 18
NJ-4535	3,5 (3,3 to 3,7)	4,8 to 8	0,5 to 8	4,8 to 12	4,1 to 18
NJ-4540	4 (3,8 to 4,3)	5,4 to 8	0,5 to 8	5,4 to 12	4,6 to 18
NJ-4545	5 (4,8 to 5,1)	6,2 to 10	0,5 to 8	6,2 to 12	5,6 to 18

References

Dispensers		Additional rails	
Model	Code	Model	Code
Dispenser OHTAKE NJ-2320 screw 2.0 mm	4-1510198	P/NJ23 & NJC 23 Rail R20 for screw 2.0 mm	4-1510188
Dispenser OHTAKE NJ-2323 screw 2.3 mm	4-1510199	P/NJ23 & NJC 23 Rail R23 for screw 2.3 mm	4-1510189
Dispenser OHTAKE NJ-2326 screw 2.6 mm	4-1510200	P/NJ23 & NJC 23 Rail R26 for screw 2.6 mm	4-1510190
Dispenser OHTAKE NJ-2330 screw 3.0 mm	4-1510201	P/NJ23 & NJC 23 Rail R30 for screw 3.0 mm	4-1510191
Dispenser OHTAKE NJ-4535 screw 3.5 mm	4-1510202	P/NJ45 & NJC 23 Rail R35 for screw 3.5 mm	4-1510192
Dispenser OHTAKE NJ-4540 screw 4.0 mm	4-1510203	P/NJ45 & NJC 23 Rail R40 for screw 4.0 mm	4-1510193
Dispenser OHTAKE NJ-4550 screw 5.0 mm	4-1510204	P/NJ45 & NJC 23 Rail R50 for screw 5.0 mm	4-1510194

Features

Model	External dimensions	Screw capacity	Overload protection/recovery circuit	External signal line
NJ-2320	129,4 x 215 x 139 (H)	ENV 150 CC	Yes	Yes
NJ-2323			Yes	Yes
NJ-2326			Yes	Yes
NJ-2330			Yes	Yes
NJ-4535			Yes	Yes
NJ-4540			Yes	Yes
NJ-4545			Yes	Yes

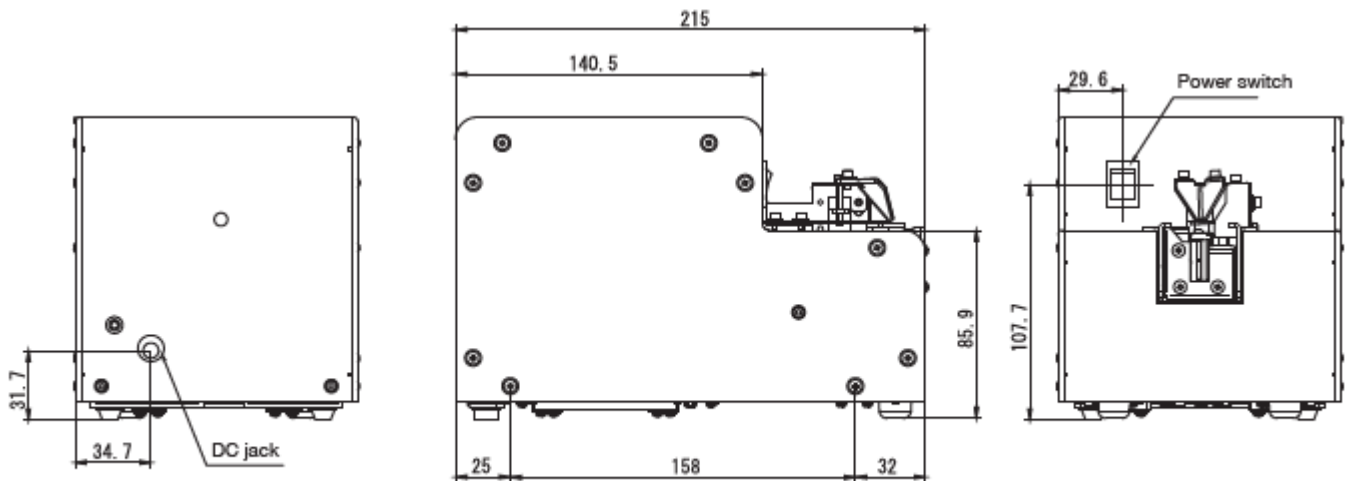
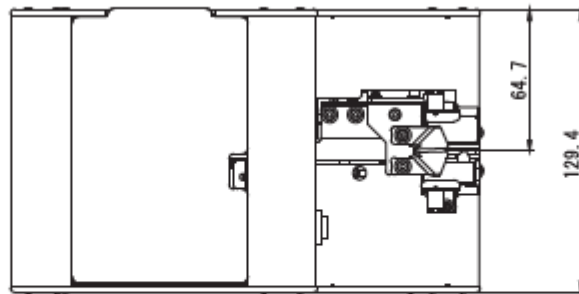

NJL SERIE



Take out type

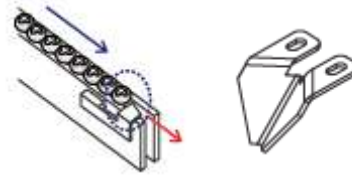

- ▶ Suitable for a longer range of screws than the NJ series, 25 mm instead of 18 mm.
- ▶ Suitable for a wide range of screw types.

Suitable screws

Model	Suitable \varnothing screw body (mm)	Suitable \varnothing screw head (mm)	Suitable H screw (mm)	Suitable washer \varnothing (mm)	Screw shaft length (mm)
NJL-2320	2 (1,8 to 2,1)	3 to 3,5	0,5 to 5,5	3 to 8	2,6 to 25
NJL-2323	2,3 (2,1 to 2,4)	3 to 4	0,5 to 5,5	3 to 8	2,9 to 25
NJL-2326	2,6 (2,4 to 2,7)	3,6 to 4,5	0,5 to 5,5	3 to 8	3,2 to 25
NJL-2330	3 (2,8 to 3,1)	4 to 5,5	0,5 to 5,5	4 to 8	3,6 to 25
NJL-4535	3,5 (3,3 to 3,7)	4,8 to 8	0,5 to 8	4,8 to 12	4,1 to 25
NJL-4540	4 (3,8 to 4,3)	5,4 to 8	0,5 to 8	5,4 to 12	4,6 to 25
NJL-4545	5 (4,8 to 5,1)	6,2 to 10	0,5 to 8	6,2 to 12	5,6 to 25

References

Dispensers		Additional rails	
Model	Code	Model	Code
Dispenser OHTAKE NJL-2320 screw 2.0 mm	4-1510500	P/NJL-23 Rail RL20 for screw 2.0 mm	4-1500020
Dispenser OHTAKE NJL-2323 screw 2.3 mm	4-1510501	P/NJL-23 Rail RL23 for screw 2.3 mm	4-1500024
Dispenser OHTAKE NJL-2326 screw 2.6 mm	4-1510502	P/NJL-23 Rail RL26 for screw 2.6 mm	4-1500026
Dispenser OHTAKE NJL-2330 screw 3.0 mm	4-1510503	P/NJL-23 Rail RL30 for screw 3.0 mm	4-1500027
Dispenser OHTAKE NJL-4535 screw 3.5 mm	4-1510504	P/NJL-45 Rail RL35 for screw 3.5 mm	4-1500028
Dispenser OHTAKE NJL-4540 screw 4.0 mm	4-1510505	P/NJL-45 Rail RL40 for screw 4.0 mm	4-1500029
Dispenser OHTAKE NJL-4550 screw 5.0 mm	4-1510506	P/NJL-45 Rail RL50 for screw 5.0 mm	4-1500031

Features

Model	External dimensions	Screw capacity	Overload protection/recovery circuit	External signal line
NJL-2320	129,4 x 215 x 139 (H)	ENV 150 CC	Yes	Yes
NJL-2323			Yes	Yes
NJL-2326			Yes	Yes
NJL-2330			Yes	Yes
NJL-4535			Yes	Yes
NJL-4540			Yes	Yes
NJL-4545			Yes	Yes

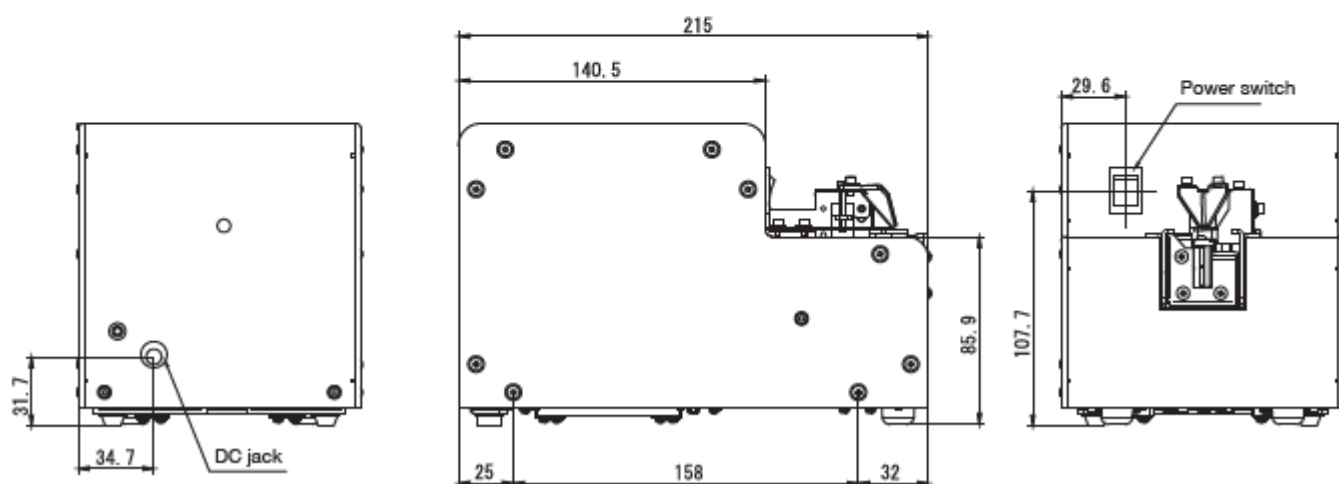
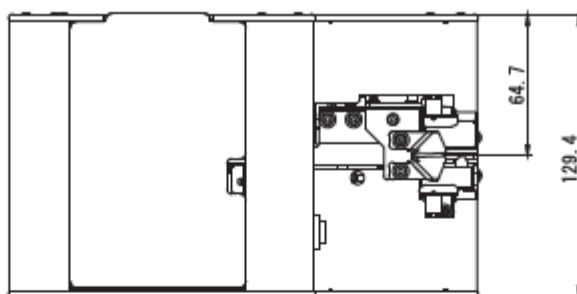

NJC SERIE

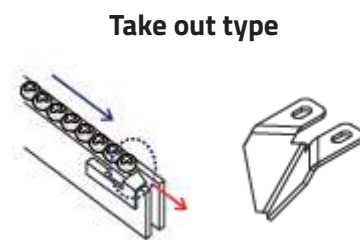

- ▶ Display of the number of screws distributed (counter per increment).
- ▶ Display of the number of screws remaining to be dispensed (counter by decrementing from a configurable setpoint).

Suitable screws

Model	Suitable Ø screw body (mm)	Suitable Ø screw head (mm)	Suitable H screw (mm)	Suitable washer Ø (mm)	Screw shaft length (mm)
NJC-2320	2 (1,8 to 2,1)	3 to 3,5	0,5 to 5,5	3 to 8	2,6 to 18
NJC-2323	2,3 (2,1 to 2,4)	3 to 4	0,5 to 5,5	3 to 8	2,9 to 18
NJC-2326	2,6 (2,4 to 2,7)	3,6 to 4,5	0,5 to 5,5	3 to 8	3,2 to 18
NJC-2330	3 (2,8 to 3,1)	4 to 5,5	0,5 to 5,5	4 to 8	3,6 to 18
NJC-4535	3,5 (3,3 to 3,7)	4,8 to 8	0,5 to 8	4,8 to 12	4,1 to 18
NJC-4540	4 (3,8 to 4,3)	5,4 to 8	0,5 to 8	5,4 to 12	4,6 to 18
NJC-4545	5 (4,8 to 5,1)	6,2 to 10	0,5 to 8	6,2 to 12	5,6 to 18

References

Dispensers		Additional rails	
Model	Code	Model	Code
Dispenser OHTAKE NJC-2320 screw 2.0 mm	4-1510109	P/NJ23 & NJC23 Rail R20 for screw 2.0 mm	4-1510188
Dispenser OHTAKE NJC-2323 screw 2.3 mm	4-1510110	P/NJ23 & NJC23 Rail R23 for screw 2.3 mm	4-1510189
Dispenser OHTAKE NJC-2326 screw 2.6 mm	4-1510111	P/NJ23 & NJC23 Rail R26 for screw 2.6 mm	4-1510190
Dispenser OHTAKE NJC-2330 screw 3.0 mm	4-1510112	P/NJ23 & NJC23 Rail R30 for screw 3.0 mm	4-1510191
Dispenser OHTAKE NJC-4535 screw 3.5 mm	4-1510113	P/NJ45 & NJC45 Rail R35 for screw 3.5 mm	4-1510192
Dispenser OHTAKE NJC-4540 screw 4.0 mm	4-1510114	P/NJ45 & NJC45 Rail R40 for screw 4.0 mm	4-1510193
Dispenser OHTAKE NJC-4550 screw 5.0 mm	4-1510115	P/NJ45 & NJC45 Rail R50 for screw 5.0 mm	4-1510194

Features

Model	External dimensions	Screw capacity	Overload protection/recovery circuit	External signal line
NJC-2320	129,4 x 215 x 139 (H)	ENV 150 CC	Yes	Yes
NJC-2323			Yes	Yes
NJC-2326			Yes	Yes
NJC-2330			Yes	Yes
NJC-4535			Yes	Yes
NJC-4540			Yes	Yes
NJC-4545			Yes	Yes

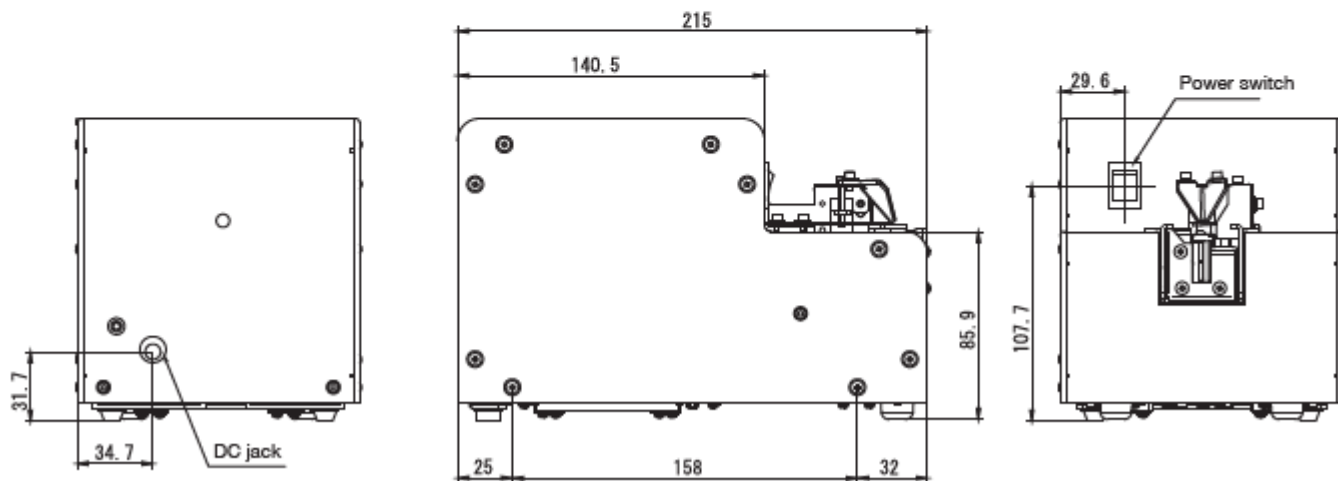
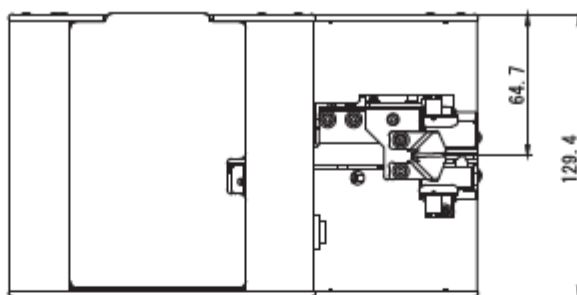

NSB SERIE



Take out type

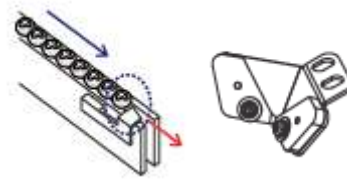

- ▶ The exchange of rails makes it possible to adapt to different screw diameters with a single unit.
- ▶ Reduced size to save space on the workstation.

Suitable screws

Model	Suitable Ø screw body (mm)	Suitable Ø screw head (mm)	Suitable H screw (mm)	Screw shaft length (mm)
NSB-10	1 (0,9 to 0,95)	1,2 to 4,5	0,35 to 1	1,6 to 10
NSB-12	1,2 (1,1 to 1,15)	1,4 to 4,5	0,35 to 1	1,8 to 10
NSB-14	1,4 (1,3 to 1,4)	1,7 to 4,5	0,35 to 1	2 to 10
NSB-17	1,7 (1,6 to 1,7)	2 to 4,5	0,35 to 1	2,3 to 10
NSB-20	2 (1,9 to 2,1)	2,4 to 6	0,35 to 4,5	2,6 to 20
NSB-23	2,3 (2,2 to 2,4)	2,7 to 6	0,35 to 4,5	2,9 to 20
NSB-26	2,6 (2,5 to 2,7)	3 to 6	0,35 to 4,5	3,2 to 20
NSB-30	3 (2,9 to 3,2)	3,5 to 6	0,35 to 4,5	3,6 to 20

References

Dispensers		Additional rails	
Model	Code	Model	Code
Dispenser OHTAKE NSB-10 screw 1.0 mm	4-1510574	P/NSB & NSBC Rail SR10 for screw 1.0 mm	4-1510549
Dispenser OHTAKE NSB-12 screw 1.2 mm	4-1510575	P/NSB & NSBC Rail SR12 for screw 1.2 mm	4-1510550
Dispenser OHTAKE NSB-14 screw 1.4 mm	4-1510576	P/NSB & NSBC Rail SR14 for screw 1.4 mm	4-1510551
Dispenser OHTAKE NSB-17 screw 1.7 mm	4-1510577	P/NSB & NSBC Rail SR17 for screw 1.7 mm	4-1510552
Dispenser OHTAKE NSB-20 screw 2.0 mm	4-1510578	P/NSB & NSBC Rail SR20 for screw 2.0 mm	4-1510553
Dispenser OHTAKE NSB-23 screw 2.3 mm	4-1510579	P/NSB & NSBC Rail SR23 for screw 2.3 mm	4-1510554
Dispenser OHTAKE NSB-26 screw 2.6 mm	4-1510580	P/NSB & NSBC Rail SR26 for screw 2.6 mm	4-1510555
Dispenser OHTAKE NSB-30 screw 3.0 mm	4-1510581	P/NSB & NSBC Rail SR30 for screw 3.0 mm	4-1510556

Features

Model	External dimensions	Screw capacity	Overload protection/recovery circuit	External signal line
NSB-10	123 x 181 x 144 (H)	ENV 80 CC	Yes	Yes
NSB-12			Yes	Yes
NSB-14			Yes	Yes
NSB-17			Yes	Yes
NSB-20			Yes	Yes
NSB-23			Yes	Yes
NSB-26			Yes	Yes
NSB-30			Yes	Yes

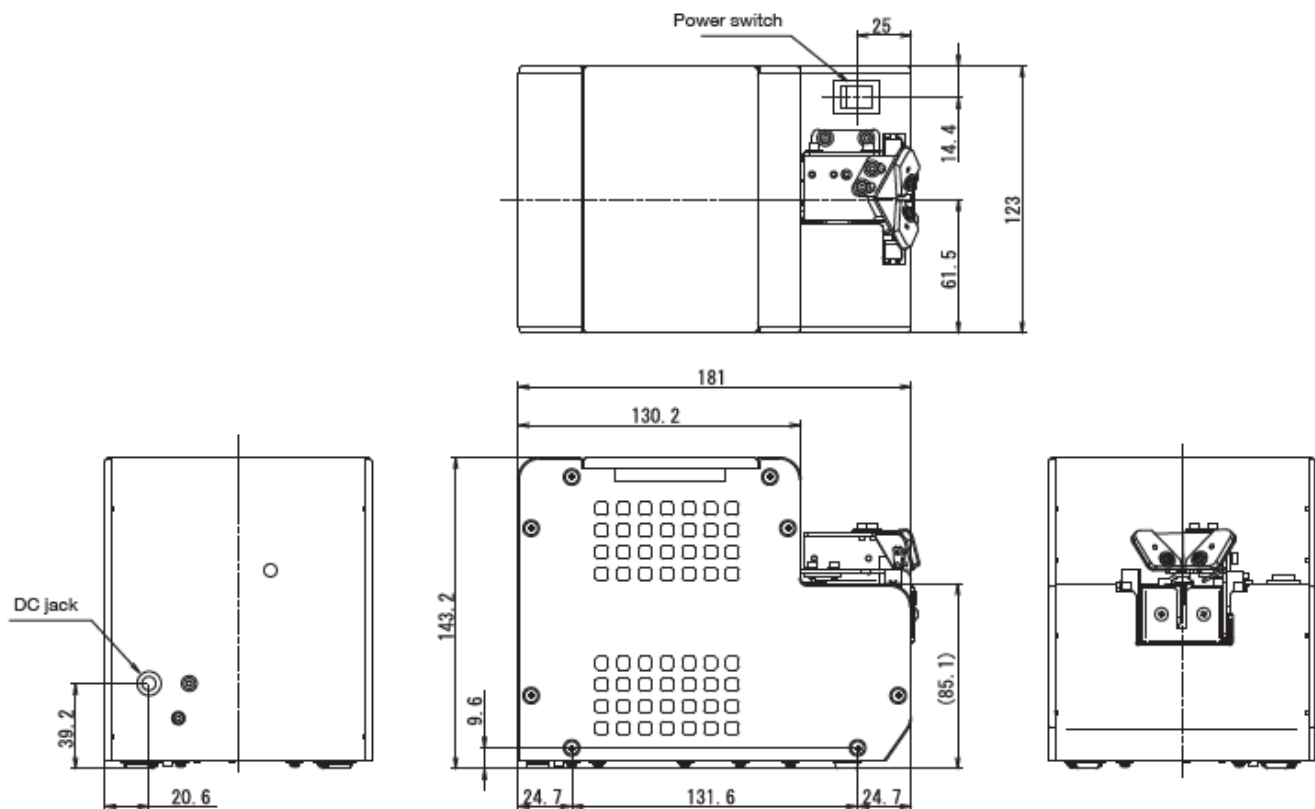

NSBI SERIE



Take out type

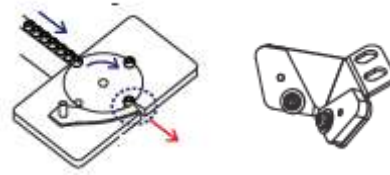

- ▶ High Precision.
- ▶ Rotary separator allowing a high speed of distribution up to 1 screw every 0.9 sec.
- ▶ Increased durability thanks to a rotary separator.

Suitable screws

Model	Suitable Ø screw body (mm)	Suitable Ø screw head (mm)	Suitable H screw (mm)	Screw shaft length (mm)
NSBI-10	1 (0,9 to 0,95)	1,2 to 4,5	0,35 to 1	1,6 to 10
NSBI-12	1,2 (1,1 to 1,15)	1,4 to 4,5	0,35 to 1	1,8 to 10
NSBI-14	1,4 (1,3 to 1,4)	1,7 to 4,5	0,35 to 1	2 to 10
NSBI-17	1,7 (1,6 to 1,7)	2 to 4,5	0,35 to 1	2,3 to 10
NSBI-20	2 (1,9 to 2,1)	2,4 to 6	0,35 to 4,5	2,6 to 20
NSBI-23	2,3 (2,2 to 2,4)	2,7 to 6	0,35 to 4,5	2,9 to 20
NSBI-26	2,6 (2,5 to 2,7)	3 to 6	0,35 to 4,5	3,2 to 20
NSBI-30	3 (2,9 to 3,2)	3,5 to 6	0,35 to 4,5	3,6 to 20

References

Dispensers		Additional rails	
Model	Code	Model	Code
Dispenser OHTAKE NSBI-10 screw 1.0 mm	4-1510616	P/NSBI Rail BI10 for screw 1.0 mm	4-1510624
Dispenser OHTAKE NSBI-12 screw 1.2 mm	4-1510617	P/NSBI Rail BI12 for screw 1.2 mm	4-1510625
Dispenser OHTAKE NSBI-14 screw 1.4 mm	4-1510618	P/NSBI Rail BI14 for screw 1.4 mm	4-1510626
Dispenser OHTAKE NSBI-17 screw 1.7 mm	4-1510619	P/NSBI Rail BI17 for screw 1.7 mm	4-1510627
Dispenser OHTAKE NSBI-20 screw 2.0 mm	4-1510620	P/NSBI Rail BI20 for screw 2.0 mm	4-1510628
Dispenser OHTAKE NSBI-23 screw 2.3 mm	4-1510621	P/NSBI Rail BI23 for screw 2,3 mm	4-1510629
Dispenser OHTAKE NSBI-26 screw 2.6 mm	4-1510622	P/NSBI Rail BI26 for screw 2.6 mm	4-1510630
Dispenser OHTAKE NSBI-30 screw 3.0 mm	4-1510623	P/NSBI Rail BI30 for screw 3.0 mm	4-1510631

Features

Model	External dimensions	Screw capacity	Overload protection/recovery circuit	External signal line
NSBI-10	123 x 181 x 145 (H)	ENV 80 CC	Yes	Yes
NSBI-12			Yes	Yes
NSBI-14			Yes	Yes
NSBI-17			Yes	Yes
NSBI-20			Yes	Yes
NSBI-23			Yes	Yes
NSBI-26			Yes	Yes
NSBI-30			Yes	Yes

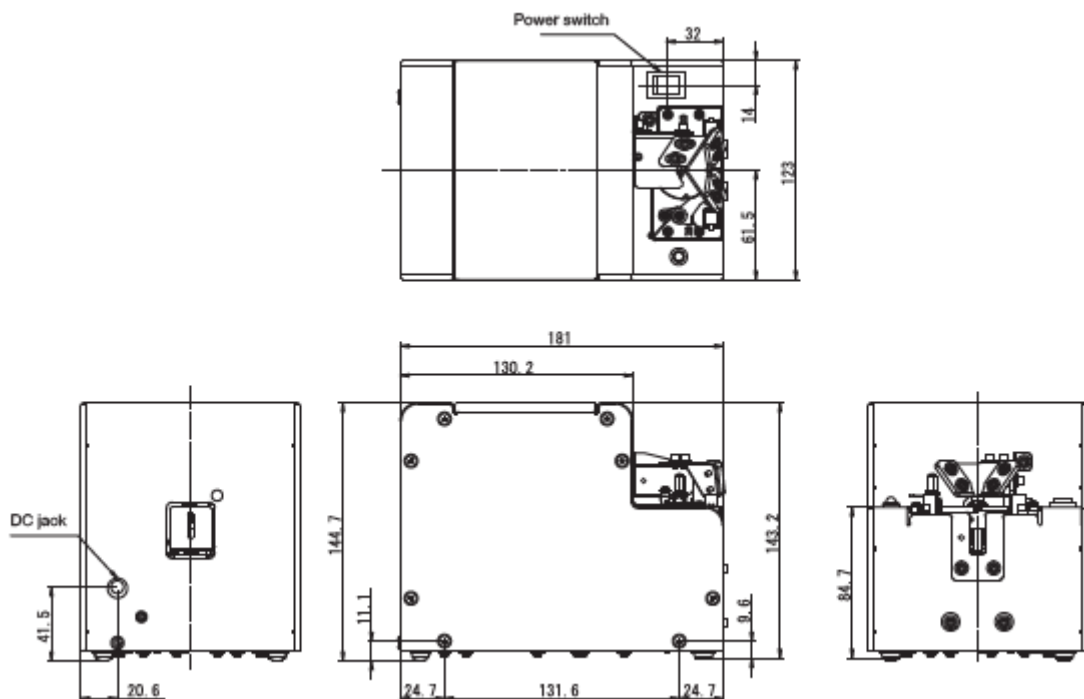

SS SERIE



Take out type

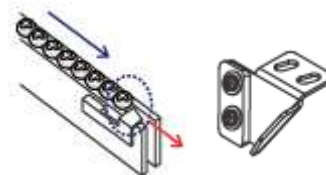

- ▶ Small width for installation next to each other.
- ▶ Suitable for screws with a thin head.
- ▶ Adjustable conveying speed.

Suitable screws

Model	Suitable \varnothing screw body (mm)	Suitable \varnothing screw head (mm)	Suitable H screw (mm)	Suitable washer \varnothing (mm)	Screw shaft length (mm)
SS-1210	1 (0,9 to 0,95)	1,2 to 2	0,35 to 1	NA	1,6 to 10
SS-1212	1,2 (1,1 to 1,15)	1,4 to 2,3	0,35 to 1	NA	1,8 to 10
SS-1214	1,4 (1,3 to 1,4)	1,7 to 2,5	0,35 to 1	NA	2 to 10
SS-1217	1,7 (1,6 to 1,7)	2 to 3	0,35 to 1	NA	2,3 to 10
SS-1220	2 (1,9 to 2,1)	2,4 to 4	0,35 to 1,3	2,4 to 6	2,6 to 16
SS-2323	2,3 (2,2 to 2,4)	2,7 to 4	0,35 to 1,5	2,7 to 7	2,9 to 16
SS-2326	2,6 (2,5 to 2,7)	3 to 4,5	0,35 to 1,7	3 to 7,5	3,2 to 16
SS-2330	3 (2,9 to 3,2)	3,5 to 5,5	0,35 to 2	3,5 to 8	3,6 to 16

References

Dispensers		Additional rails	
Model	Code	Model	Code
Dispenser OHTAKE SS-1210 screw 1.0 mm	4-1510170	P/SS-12 Rail WR10 for screw 1.0 mm	4-1510210
Dispenser OHTAKE SS-1212 screw 1.2 mm	4-1510171	P/SS-12 Rail WR12 for screw 1.2 mm	4-1510211
Dispenser OHTAKE SS-1214 screw 1.4 mm	4-1510172	P/SS-12 Rail WR14 for screw 1.4 mm	4-1510212
Dispenser OHTAKE SS-1217 screw 1.7 mm	4-1510173	P/SS-12 Rail WR17 for screw 1.7 mm	4-1510213
Dispenser OHTAKE SS-1220 screw 2.0 mm	4-1510174	P/SS-12 Rail WR20 for screw 2.0 mm	4-1510214
Dispenser OHTAKE SS-2323 screw 2.3 mm	4-1510175	P/SS-12 Rail WR23 for screw 2.3 mm	4-1510215
Dispenser OHTAKE SS-2326 screw 2.6 mm	4-1510176	P/SS-12 Rail WR26 for screw 2.6 mm	4-1510216
Dispenser OHTAKE SS-2330 screw 3.0 mm	4-1510177	P/SS-12 Rail WR30 for screw 3.0 mm	4-1510217

Features

Model	External dimensions	Screw capacity	Overload protection/recovery circuit	External signal line
SS-1210	55 x 205 x 143 (H)	ENV 40 CC	Yes	Yes
SS-1212			Yes	Yes
SS-1214			Yes	Yes
SS-1217			Yes	Yes
SS-1220			Yes	Yes
SS-2323			Yes	Yes
SS-2326			Yes	Yes
SS-2330			Yes	Yes

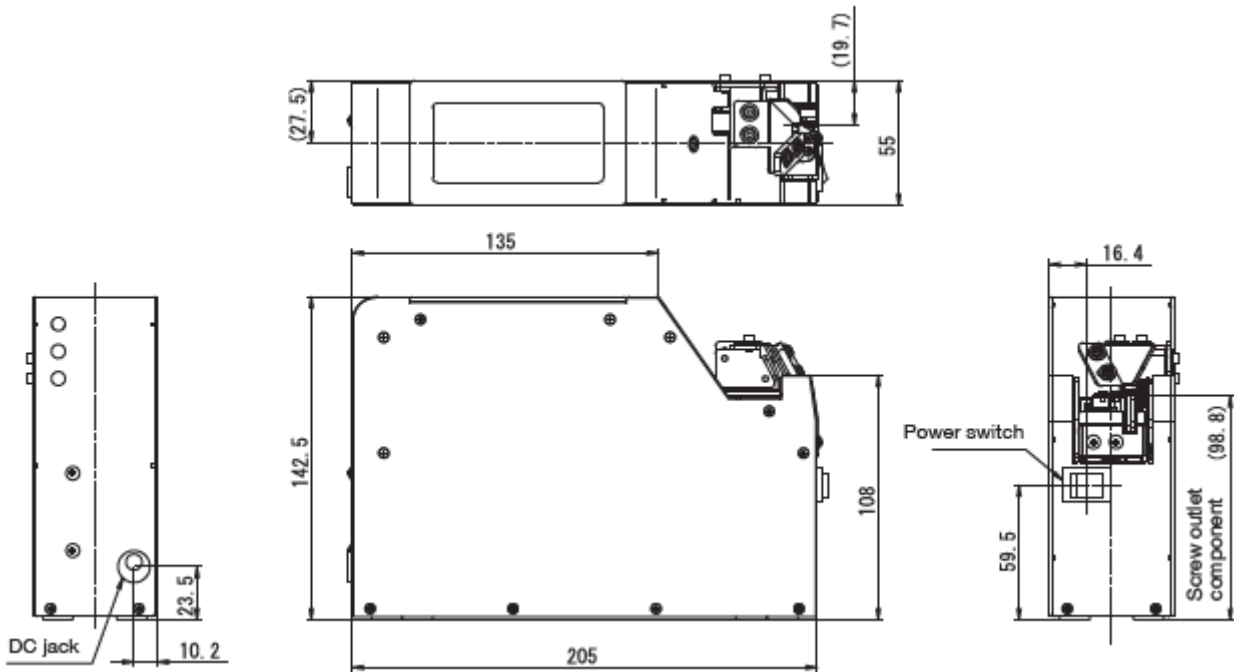

OM-26M SERIE

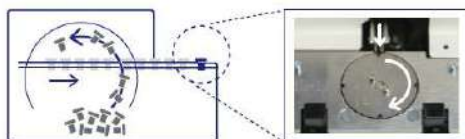

Take out type

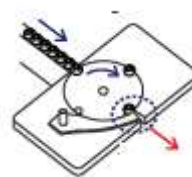

- ▶ Rotative separator allowing a high speed of distribution up to 1 screw every 0.9 sec.
- ▶ High capacity up to 300 CC (about 780 M3 x 12 screws).
- ▶ Brushless motor for long life.

Suitable screws

Model	Suitable Ø screw body (mm)	Suitable Ø screw head (mm)	Suitable H screw (mm)	Suitable washer Ø (mm)	Screw shaft length (mm)
OM-26M20	2 (1,9 to 2,1)	2,4 to 6	0,35 to 6	2,4 to 10	2,6 to 25
OM-26M23	2,3 (2,2 to 2,4)	2,7 to 6	0,35 to 6	2,7 to 10	2,9 to 25
OM-26M26	2,6 (2,5 to 2,7)	3 to 6	0,35 to 6	3 to 10	3,2 to 25
OM-26M30	3 (2,9 to 3,2)	3,5 to 6	0,35 to 6	3,5 to 11	3,6 to 25
OM-26M35	3,5 (3,4 to 3,7)	4 to 8	0,35 to 6,5	4 to 11	4,1 to 25
OM-26M40	4 (3,8 to 4,2)	4,5 to 8	0,35 to 6,5	4,5 to 12	4,6 to 25
OM-26M50	5 (4,8 to 5,2)	5,5 to 10	0,35 to 7	5,5 to 12	5,6 to 25
OM-26M60	6 (5,8 to 6,2)	6,5 to 11	0,35 to 7,5	6,5 to 12	6,6 to 25

References

Dispensers		Additional rails	
Model	Code	Model	Code
Dispenser OHTAKE OM-26M20 screw 2.0 mm	4-1510600	P/OM-26M Rail OMM20 for screw 2.0 mm	4-1510608
Dispenser OHTAKE OM-26M23 screw 2.3 mm	4-1510601	P/OM-26M Rail OMM23 for screw 2.3 mm	4-1510609
Dispenser OHTAKE OM-26M26 screw 2.6 mm	4-1510602	P/OM-26M Rail OMM26 for screw 2.6 mm	4-1510610
Dispenser OHTAKE OM-26M30 screw 3.0 mm	4-1510603	P/OM-26M Rail OMM30 for screw 3.0 mm	4-1510611
Dispenser OHTAKE OM-26M35 screw 3.5 mm	4-1510604	P/OM-26M Rail OMM35 for screw 3.5 mm	4-1510612
Dispenser OHTAKE OM-26M40 screw 4.0 mm	4-1510605	P/OM-26M Rail OMM40 for screw 4.0 mm	4-1510613
Dispenser OHTAKE OM-26M50 screw 5.0 mm	4-1510606	P/OM-26M Rail OMM50 for screw 5.0 mm	4-1510614
Dispenser OHTAKE OM-26M60 screw 6.0 mm	4-1510607	P/OM-26M Rail OMM60 for screw 6.0 mm	4-1510615

Features

Model	External dimensions	Screw capacity	Overload protection/recovery circuit	External signal line
OM-26M20	119 x 226 x 152 (H)	ENV 300 CC	Yes	Yes
OM-26M23			Yes	Yes
OM-26M26			Yes	Yes
OM-26M30			Yes	Yes
OM-26M35			Yes	Yes
OM-26M40			Yes	Yes
OM-26M50			Yes	Yes
OM-26M60			Yes	Yes

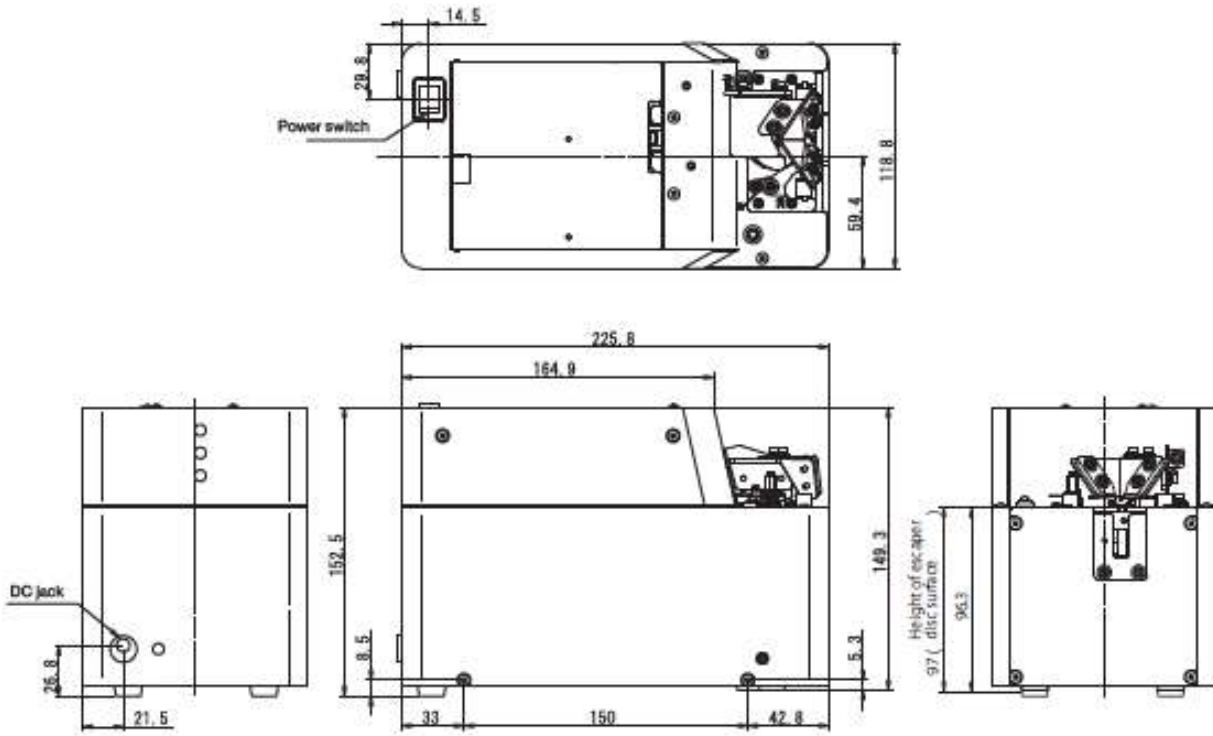

NJR SERIE

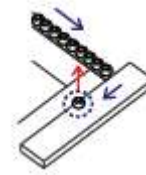

- ▶ Suitable for robotic applications.
- ▶ Side separation of the screw.
- ▶ Allows stable presentation of SW screws or screws with washers.

Suitable screws

Model	Suitable Ø screw body (mm)	Suitable Ø screw head (mm)	Suitable H screw (mm)	Suitable washer Ø (mm)	Screw shaft length (mm)
NJR 20	2 (1,8 to 2,1)	3 to 3,5	0,5 to 5,5	3 to 9,8	2,6 to 18
NJR 23	2,3 (2,1 to 2,4)	3 to 4	0,5 to 5,5	3 to 9,8	2,9 to 18
NJR 26	2,6 (2,4 to 2,7)	3,6 to 4,5	0,5 to 5,5	3,6 to 9,8	3,2 to 18
NJR 30	3 (2,8 to 3,2)	4 to 5,5	0,5 to 5,5	4 to 9,8	3,6 to 18
NJR 35	3,5 (3,3 to 3,7)	4,8 to 8	0,5 to 8	4,8 to 11,5	4,1 to 18
NJR 40	4 (3,8 to 4,3)	5,4 to 8	0,5 to 8	5,4 to 11,5	4,6 to 18
NJR 45	5 (4,8 to 5,1)	6,2 to 10	0,5 to 8	6,2 to 11,5	5,6 to 18

References

Dispensers		Additional rails	
Model	Code	Model	Code
Dispenser OHTAKE NJR23 screw 2.0 mm	4-1510230	P/NJR-23 Rail RR20 for screw 2.0 mm	4-1510567
Dispenser OHTAKE NJR23 screw 2.3 mm	4-1510231	P/NJR-23 Rail RR23 for screw 2.3 mm	4-1510568
Dispenser OHTAKE NJR23 screw 2.6 mm	4-1510232	P/NJR-23 Rail RR26 for screw 2.6 mm	4-1510569
Dispenser OHTAKE NJR23 screw 3.0 mm	4-1510233	P/NJR-23 Rail RR30 for screw 3.0 mm	4-1510570
Dispenser OHTAKE NJR45 screw 3.5 mm	4-1510234	P/NJR-45 Rail RR35 for screw 3.5 mm	4-1510571
Dispenser OHTAKE NJR45 screw 4.0 mm	4-1510235	P/NJR-45 Rail RR40 for screw 4.0 mm	4-1510572
Dispenser OHTAKE NJR45 screw 5.0 mm	4-1510236	P/NJR-45 Rail RR50 for screw 5.0 mm	4-1510573

Features

Model	External dimensions	Screw capacity	Overload protection/recovery circuit	External signal line
NJR-20	134 x 274 x 139 (H)	ENV 150 CC	Yes	Yes
NJR-23			Yes	Yes
NJR-26			Yes	Yes
NJR-30			Yes	Yes
NJR-35			Yes	Yes
NJR-40			Yes	Yes
NJR-45			Yes	Yes

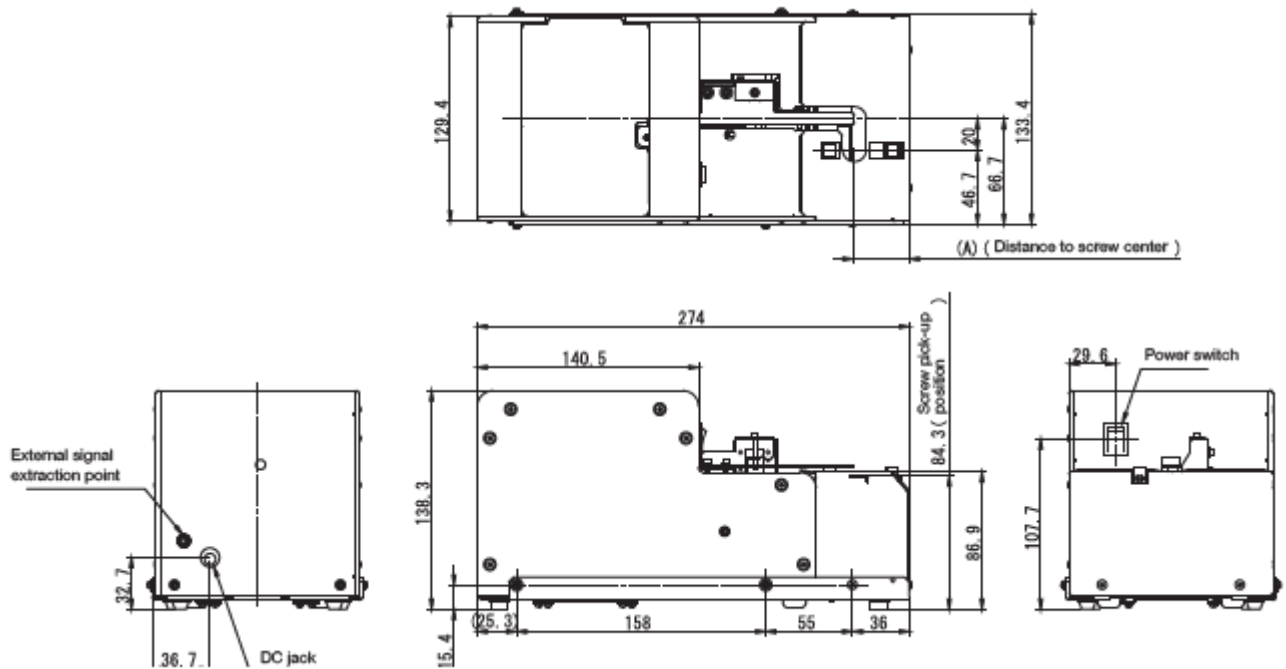

NJRL SERIE

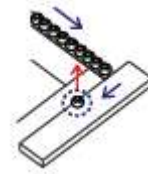

- ▶ Suitable for robotic applications.
- ▶ Side separation of the screw.
- ▶ Allows stable presentation of SW screws or screws with washers.
- ▶ Screw length up to 25 mm.

Suitable screws

Model	Suitable \varnothing screw body (mm)	Suitable \varnothing screw head (mm)	Suitable H screw (mm)	Suitable washer \varnothing (mm)	Screw shaft length (mm)
NJRL 20	2 (1,8 to 2,1)	3 to 3,5	0,5 to 5,5	3 to 9,8	2,6 to 25
NJRL 23	2,3 (2,1 to 2,4)	3 to 4	0,5 to 5,5	3 to 9,8	2,9 to 25
NJRL 26	2,6 (2,4 to 2,7)	3,6 to 4,5	0,5 to 5,5	3,6 to 9,8	3,2 to 25
NJRL 30	3 (2,8 to 3,2)	4 to 5,5	0,5 to 5,5	4 to 9,8	3,6 to 25
NJRL 35	3,5 (3,3 to 3,7)	4,8 to 8	0,5 to 8	4,8 to 11,5	4,1 to 25
NJRL 40	4 (3,8 to 4,3)	5,4 to 8	0,5 to 8	5,4 to 11,5	4,6 to 25
NJRL 45	5 (4,8 to 5,1)	6,2 to 10	0,5 to 8	6,2 to 11,5	5,6 to 25

References

Dispensers		Additional rails	
Model	Code	Model	Code
Dispenser OHTAKE NJRL-2320 screw 2.0 mm	4-1510507	P/NJRL-23 Rail RRL20 for screw 2.0 mm	4-1500034
Dispenser OHTAKE NJRL-2323 screw 2.3 mm	4-1510508	P/NJRL-23 Rail RRL23 for screw 2.3 mm	4-1500037
Dispenser OHTAKE NJRL-2326 screw 2.6 mm	4-1510509	P/NJRL-23 Rail RRL26 for screw 2.6 mm	4-1500038
Dispenser OHTAKE NJRL-2330 screw 3.0 mm	4-1510510	P/NJRL-23 Rail RRL30 for screw 3.0 mm	4-1500039
Dispenser OHTAKE NJRL-4535 screw 3.5 mm	4-1510511	P/NJRL-45 Rail RRL35 for screw 3.5 mm	4-1500040
Dispenser OHTAKE NJRL-4540 screw 4.0 mm	4-1510513	P/NJRL-45 Rail RRL40 for screw 4.0 mm	4-1500041
Dispenser OHTAKE NJRL-4550 screw 5.0 mm	4-1510514	P/NJRL-45 Rail RRL50 for screw 5.0 mm	4-1500043

NSR SERIE

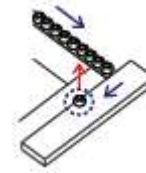

- ▶ Suitable for robotic applications.
- ▶ Side separation of the screw.

Suitable screws

Model	Suitable Ø screw body (mm)	Suitable Ø screw head (mm)	Suitable H screw (mm)	Screw shaft length (mm)
NSR 10	1 (0,9 to 0,95)	1,2 to 4,5	0,35 to 1	1,6 to 10
NSR 12	1,2 (1,1 to 1,15)	1,4 to 4,5	0,35 to 1	1,8 to 10
NSR 14	1,4 (1,3 to 1,4)	1,7 to 4,5	0,35 to 1	2 to 10
NSR 17	1,7 (1,6 to 1,7)	2 to 4,5	0,35 to 1	2,3 to 10
NSR 20	2 (1,9 to 2,1)	2,4 to 6	0,35 to 4,5	2,6 to 20
NSR 23	2,3 (2,2 to 2,4)	2,7 to 6	0,35 to 4,5	2,9 to 20
NSR 26	2,6 (2,5 to 2,7)	3 to 6	0,35 to 4,5	3,2 to 20
NSR 30	3 (2,9 to 3,2)	3,5 to 6	0,35 to 4,5	3,6 to 20

References

Dispensers		Additional rails	
Model	Code	Model	Code
Dispenser OHTAKE NSR-10 screw 1.0 mm	4-1510582	P/NSR Rail SRR10 for screw 1.0 mm	4-1510557
Dispenser OHTAKE NSR-12 screw 1.2 mm	4-1510583	P/NSR Rail SRR12 for screw 1.2 mm	4-1510558
Dispenser OHTAKE NSR-14 screw 1.4 mm	4-1510584	P/NSR Rail SRR14 for screw 1.4 mm	4-1510559
Dispenser OHTAKE NSR-17 screw 1.7 mm	4-1510585	P/NSR Rail SRR17 for screw 1.7 mm	4-1510560
Dispenser OHTAKE NSR-20 screw 2.0 mm	4-1510586	P/NSR Rail SRR20 for screw 2.0 mm	4-1510561
Dispenser OHTAKE NSR-23 screw 2.3 mm	4-1510587	P/NSR Rail SRR23 for screw 2.3 mm	4-1510562
Dispenser OHTAKE NSR-26 screw 2.6 mm	4-1510588	P/NSR Rail SRR26 for screw 2.6 mm	4-1510563
Dispenser OHTAKE NSR-30 screw 3.0 mm	4-1510589	P/NSR Rail SRR30 for screw 3.0 mm	4-1510564

NSRI SERIE

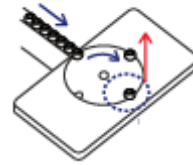

- ▶ Suitable for robotic applications.
- ▶ Rotative separator for an optimized cycle time (approx. 0.9 sec).

Suitable screws

Model	Suitable Ø screw body (mm)	Suitable Ø screw head (mm)	Suitable H screw (mm)	Screw shaft length (mm)
NSRI 10	0,9 to 0,95	1,2 to 4,5	0,35 to 1	1,6 to 10
NSRI 12	1,1 to 1,15	1,4 to 4,5	0,35 to 1	1,8 to 10
NSRI 14	1,4 (1,3 to 1,4)	1,7 to 4,5	0,35 to 1	2 to 10
NSRI 17	1,7 (1,6 to 1,7)	2 to 4,5	0,35 to 1	2,3 to 10
NSRI 20	2 (1,9 to 2,1)	2,4 to 6	0,35 to 4,5	2,6 to 20
NSRI 23	2,3 (2,2 to 2,4)	2,7 to 6	0,35 to 4,5	2,9 to 20
NSRI 26	2,6 (2,5 to 2,7)	3 to 6	0,35 to 4,5	3,2 to 20
NSRI 30	3 (2,9 to 3,2)	3,5 to 6	0,35 to 4,5	3,6 to 20

References

Dispensers		Additional rails	
Model	Code	Model	Code
Dispenser OHTAKE NSRI-10 screw 1.0 mm	4-1510632	P/NSRI Rail RI10 for screw 1.0 mm	4-1510640
Dispenser OHTAKE NSRI-12 screw 1.2 mm	4-1510633	P/NSRI Rail RI12 for screw 1.2 mm	4-1510641
Dispenser OHTAKE NSRI-14 screw 1.4 mm	4-1510634	P/NSRI Rail RI14 for screw 1.4 mm	4-1510642
Dispenser OHTAKE NSRI-17 screw 1.7 mm	4-1510635	P/NSRI Rail RI17 for screw 1.7 mm	4-1510643
Dispenser OHTAKE NSRI-20 screw 2.0 mm	4-1510636	P/NSRI Rail RI20 for screw 2.0 mm	4-1510644
Dispenser OHTAKE NSRI-23 screw 2.3 mm	4-1510637	P/NSRI Rail RI23 for screw 2.3 mm	4-1510645
Dispenser OHTAKE NSRI-26 screw 2.6 mm	4-1510638	P/NSRI Rail RI26 for screw 2.6 mm	4-1510646
Dispenser OHTAKE NSRI-30 screw 3.0 mm	4-1510639	P/NSRI Rail RI30 for screw 3.0 mm	4-1510647

Features

Model	External dimensions	Screw capacity	Overload protection/recovery circuit	External signal line
NSRI-10	123 x 181 x 145 (H)	ENV 80 CC	Yes	Yes
NSRI-12			Yes	Yes
NSRI-14			Yes	Yes
NSRI-17			Yes	Yes
NSRI-20			Yes	Yes
NSRI-23			Yes	Yes
NSRI-26			Yes	Yes
NSRI-30			Yes	Yes

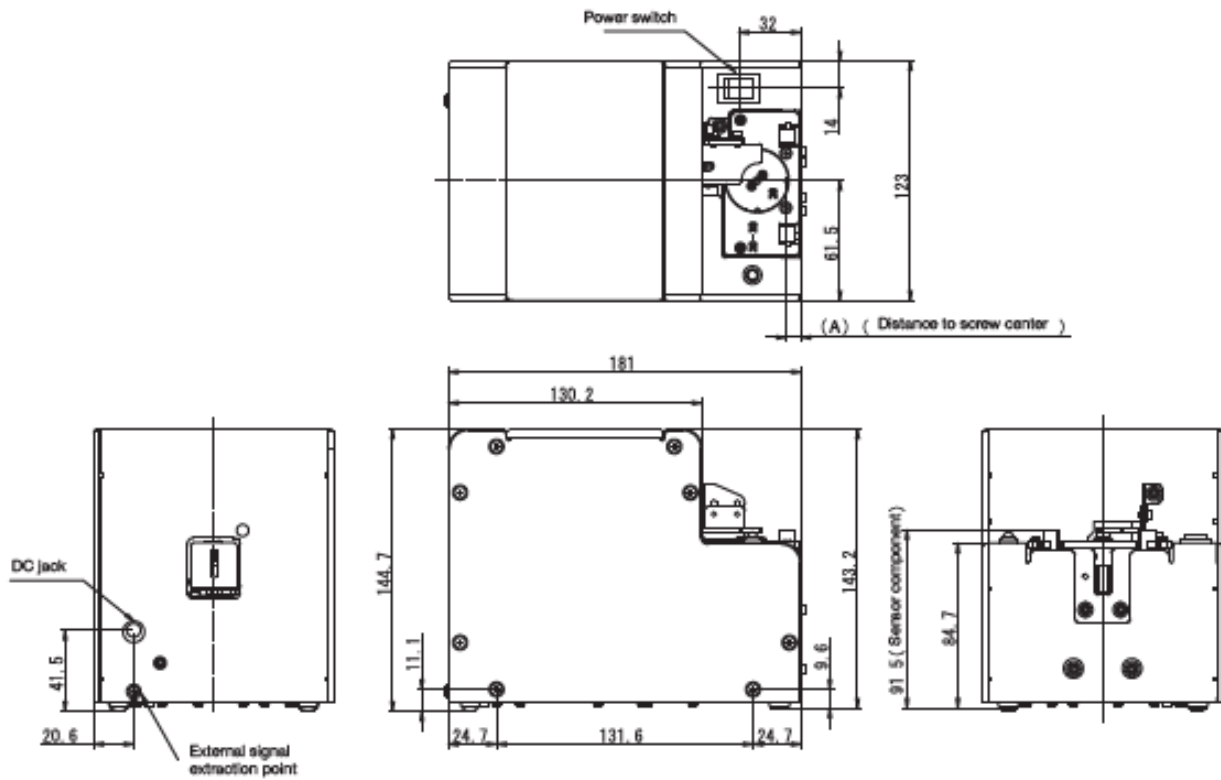

OM-26R SERIE

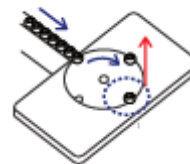

- ▶ Suitable for robotic applications.
- ▶ Rotative separator for an optimized cycle time (approx. 0.9 sec).
- ▶ Screw length up to 25 mm.

Suitable screws

Model	Suitable Ø screw body (mm)	Suitable Ø screw head (mm)	Suitable H screw (mm)	Suitable washer Ø (mm)	Screw shaft length (mm)
OM-26R20	2 (1,9 to 2,1)	2,4 to 6	0,35 to 6	2,4 to 10	2,6 to 25
OM-26R23	2,3 (2,2 to 2,4)	2,7 to 6	0,35 to 6	2,7 to 10	2,9 to 25
OM-26R26	2,6 (2,5 to 2,7)	3 to 6	0,35 to 6	3 to 10	3,2 to 25
OM-26R30	3 (2,9 to 3,2)	3,5 to 6	0,35 to 6	3,5 to 11	3,6 to 25
OM-26R35	3,5 (3,4 to 3,7)	4 to 8	0,35 to 6,5	4 to 11	4,1 to 25
OM-26R40	4 (3,8 to 4,2)	4,5 to 8	0,35 to 6,5	4,5 to 12	4,6 to 25
OM-26R50	5 (4,8 to 5,2)	5,5 to 10	0,35 to 7	5,5 to 12	5,6 to 25
OM-26R60	6 (5,8 to 6,2)	6,5 to 11	0,35 to 7,5	6,5 to 12	6,6 to 25

References

Dispensers		Additional rails	
Model	Code	Model	Code
Dispenser OHTAKE OM-26R20 screw 2.0 mm	4-1500076	P/OM - 26R Rail OMR20 for screw 2.0 mm	4-1500077
Dispenser OHTAKE OM-26R23 screw 2.3 mm	4-1500078	P/OM - 26R Rail OMR23 for screw 2.3 mm	4-1500079
Dispenser OHTAKE OM-26R26 screw 2.6 mm	4-1500080	P/OM - 26R Rail OMR26 for screw 2.6 mm	4-1500081
Dispenser OHTAKE OM-26R30 screw 3.0 mm	4-1500082	P/OM - 26R Rail OMR30 for screw 3.0 mm	4-1500083
Dispenser OHTAKE OM-26R35 screw 3.5 mm	4-1500084	P/OM - 26R Rail OMR35 for screw 3.5 mm	4-1500085
Dispenser OHTAKE OM-26R40 screw 4.0 mm	4-1500086	P/OM - 26R Rail OMR40 for screw 4.0 mm	4-1500087
Dispenser OHTAKE OM-26R50 screw 5.0 mm	4-1500088	P/OM - 26R Rail OMR50 for screw 5.0 mm	4-1500089
Dispenser OHTAKE OM-26R60 screw 6.0 mm	4-1500051	P/OM - 26R Rail OMR60 for screw 6.0 mm	4-1500052

Features

Model	External dimensions	Screw capacity	Overload protection/recovery circuit	External signal line
OM-26R20	119 x 226 x 152 (H)	ENV 300 CC	Yes	Yes
OM-26R23			Yes	Yes
OM-26R26			Yes	Yes
OM-26R30			Yes	Yes
OM-26R35			Yes	Yes
OM-26R40			Yes	Yes
OM-26R50			Yes	Yes
OM-26R60			Yes	Yes

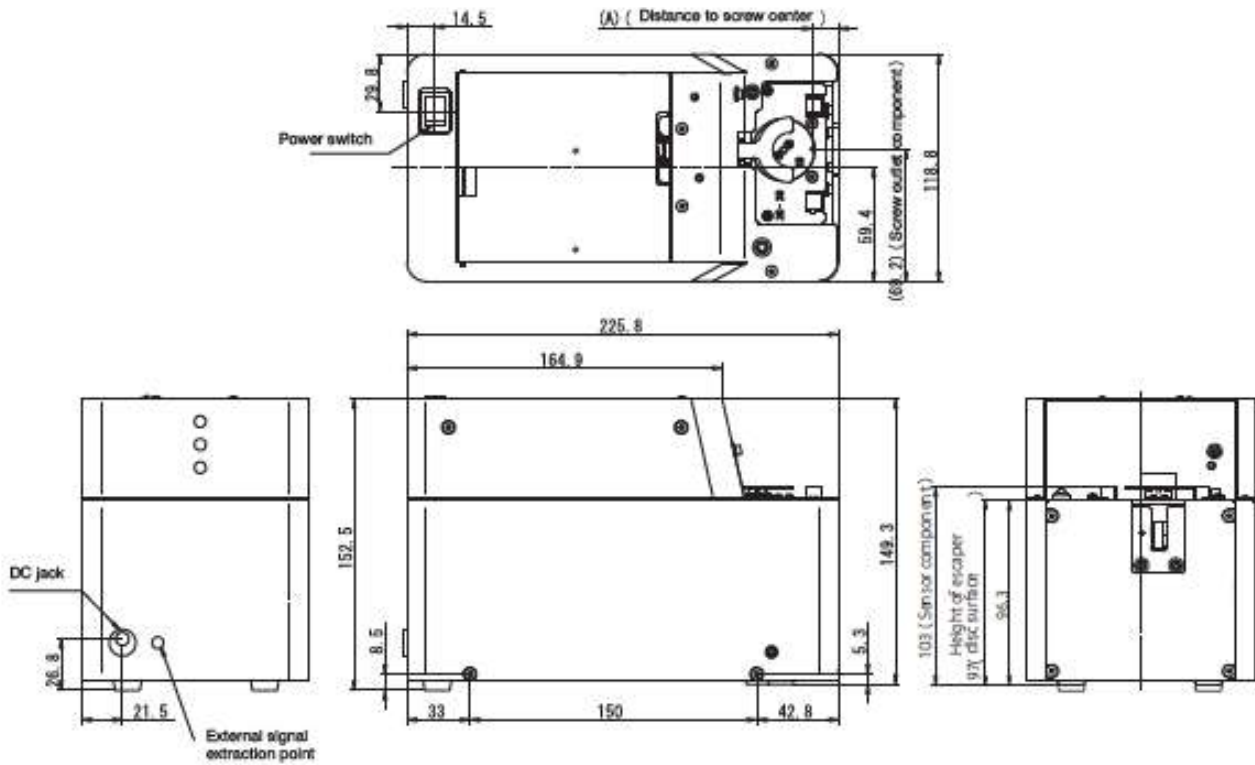

FM-36 SERIE



- ▶ Counting of fixed quantities Between 1 and 99 screws.
- ▶ The horizontal rail system ensures a stable distribution without overlapping and obstruction.
- ▶ Accepts screws of different diameters thanks to a quick change of the rail.

Suitable screws

Model	Suitable Ø screw body (mm)	Suitable Ø screw head (mm)	Suitable H screw (mm)	Suitable washer Ø (mm)	Screw shaft length (mm)
FM-3630	3 (2,8 to 3,1)	4 to 5,5	1 to 5,5	4 to 12	3,6 to 25
FM-3635	3,5 (3,3 to 3,7)	4,8 to 8	1 to 8	4,8 to 12	4,1 to 25
FM-3640	4 (3,8 to 4,1)	5,4 to 8	1 to 8	5,4 to 12	4,6 to 25
FM-3650	5 (4,8 to 5,1)	6,2 to 10	1 to 8	6,2 to 12	5,6 to 25
FM-3660	6 (5,8 to 6,2)	7,2 to 12	1 to 8	7,2 to 12	5,6 to 25

References

Dispensers		Additional rails	
Model	Code	Model	Code
Dispenser OHTAKE FM36 screw 3.0 mm	4-1510590	P/FM-36 Rail FR30 for screw 3.0 mm	4-1510595
Dispenser OHTAKE FM36 screw 3.5 mm	4-1510591	P/FM-36 Rail FR35 for screw 3.5 mm	4-1510596
Dispenser OHTAKE FM36 screw 4.0 mm	4-1510592	P/FM-36 Rail FR40 for screw 4.0 mm	4-1510597
Dispenser OHTAKE FM36 screw 5.0 mm	4-1510593	P/FM-36 Rail FR50 for screw 5.0 mm	4-1510598
Dispenser OHTAKE FM36 screw 6.0 mm	4-1510594	P/FM-36 Rail FR60 for screw 6.0 mm	4-1510599

ADDITIONAL HOPPERS

Additional hoppers



⟨ T-510 + NSR ⟩

- ▶ Easy installation: just line it up on top of the dispenser.
- ▶ Does not take up floor space.
- ▶ Increases distributor autonomy.
- ▶ Timer dispensing adjustment.

Compatibility

Model	Suitable dispensers
T-510S	NSB / NSR / NSBI / NSRI / NSRI-B
T-510J	NJ / NJR
T-510F	FM-36 / FME-36

References

Hoppers	
Model	Code
Vertical hopper T-510S P/NSB NSR NSBI NSRI	4-1510301
Vertical hopper T-510J P/NJ NJR	4-1510303
Vertical hopper T-510F P/FM-36	4-1510304

Features

Model	External dimensions	Screw capacity	Suitable \varnothing screw body (mm)	External signal line (remaining quantity sensor)
T-510S	130 x 171 x 245 (H)	ENV 400 CC and 800 CC with optional extension	M1 to M6	Yes
T-510J				Yes
T-510F				Yes

T-510S

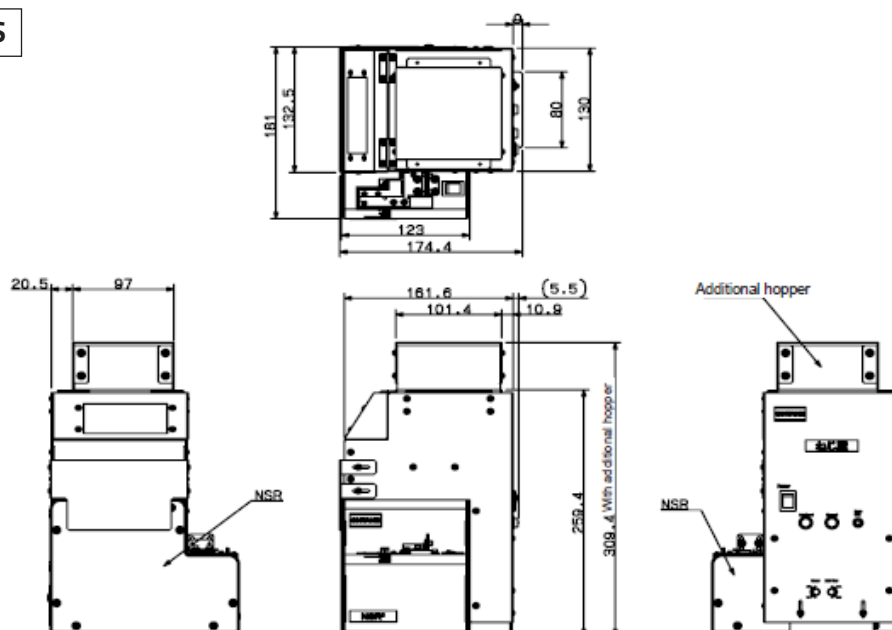

T-510J

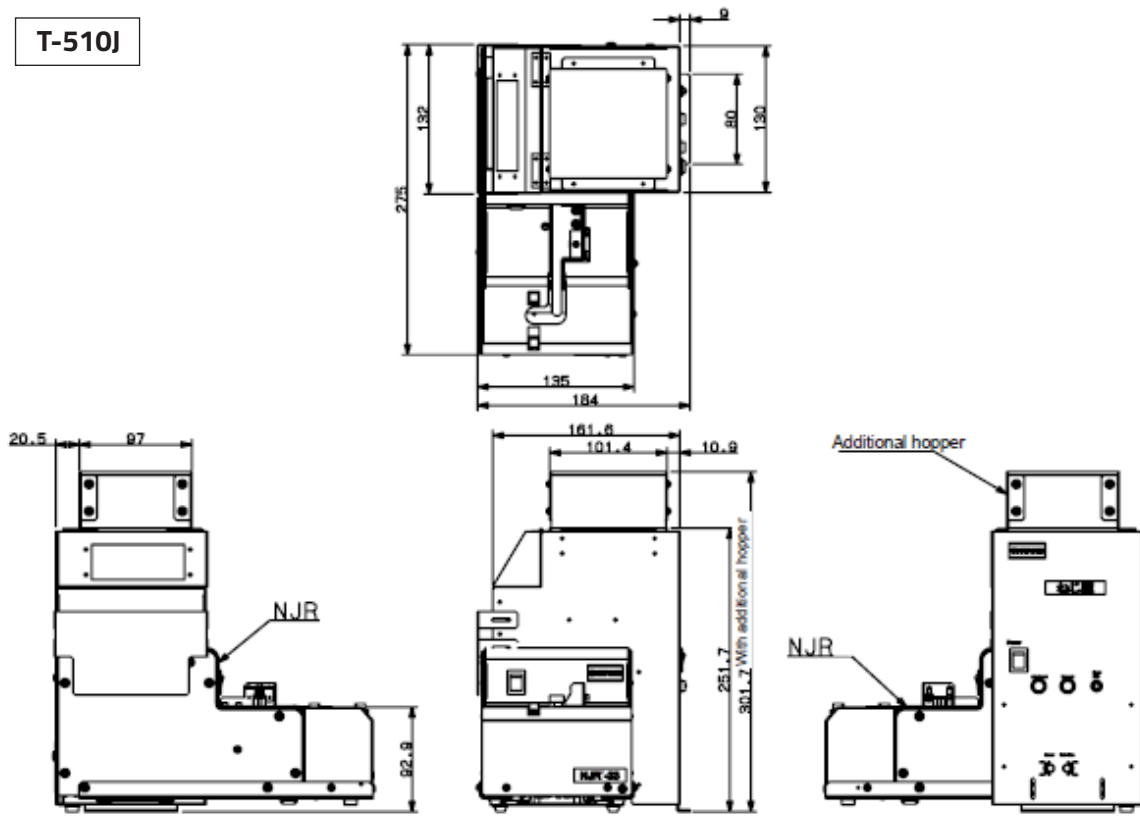

T-510F

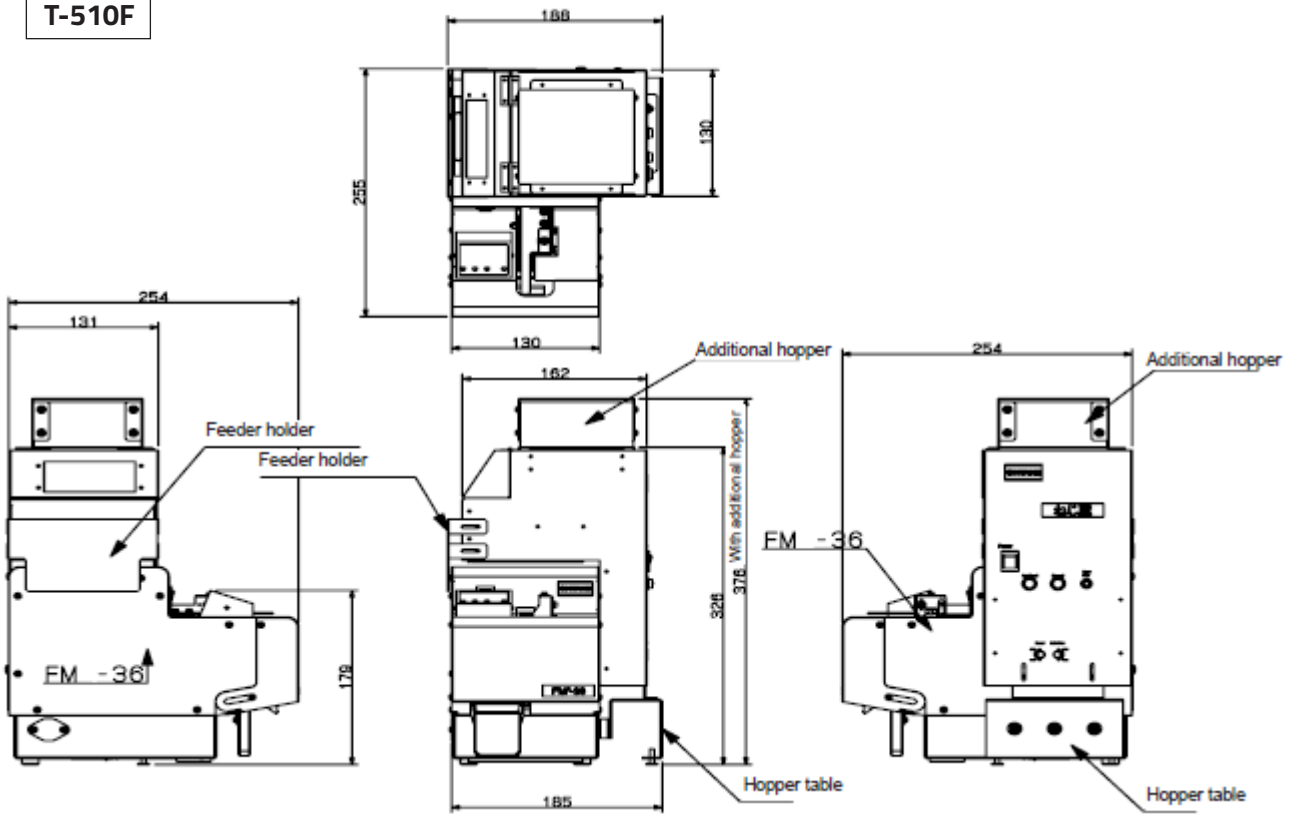

ADDITIONAL REAR HOPPERS



- ▶ Easy installation : just line it up next to the screw dispenser.
- ▶ Suitable for a stock of screws of about 800 cc.
- ▶ Timer dispensing adjustment.

Compatibility

Model	Suitable dispensers
NJ-80	NJ / NJR
NJ-80F	FM-36 / FME-36
SR-80	NSB / NSR / NSBI / NSRI / NSRI-B

References

Hoppers	
Model	Code
Rear hopper NJ-80 P/NJ NJR	4-1510299
Rear hopper NJ-80F P/FM-36	4-1510300
Rear hopper SR-80 P/NSB NSR NSBI NSRI	4-1510302

Features

Model	External dimensions	Screw capacity	Suitable \varnothing screw body (mm)	External signal line (remaining quantity sensor)
NJ-80	142 x 191 x 188 (H)	ENV 800 CC	M2 to M6	No
NJ-80F				No
SR-80	142 x 191 x 189 to 198 (H)			No

NJ-80 and dispenser NJR

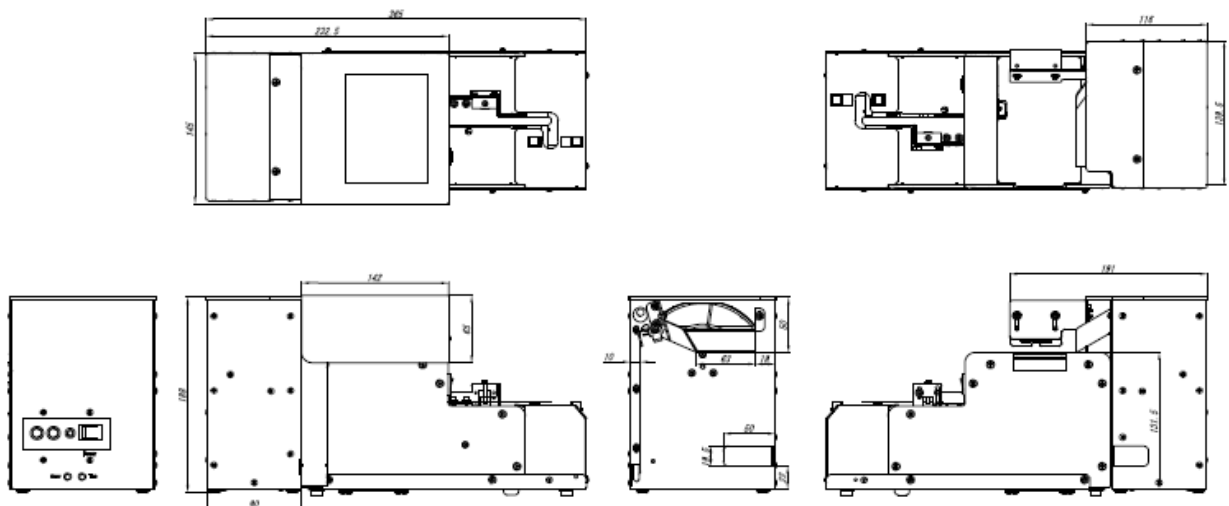

NJ-80 F and dispenser FM-36

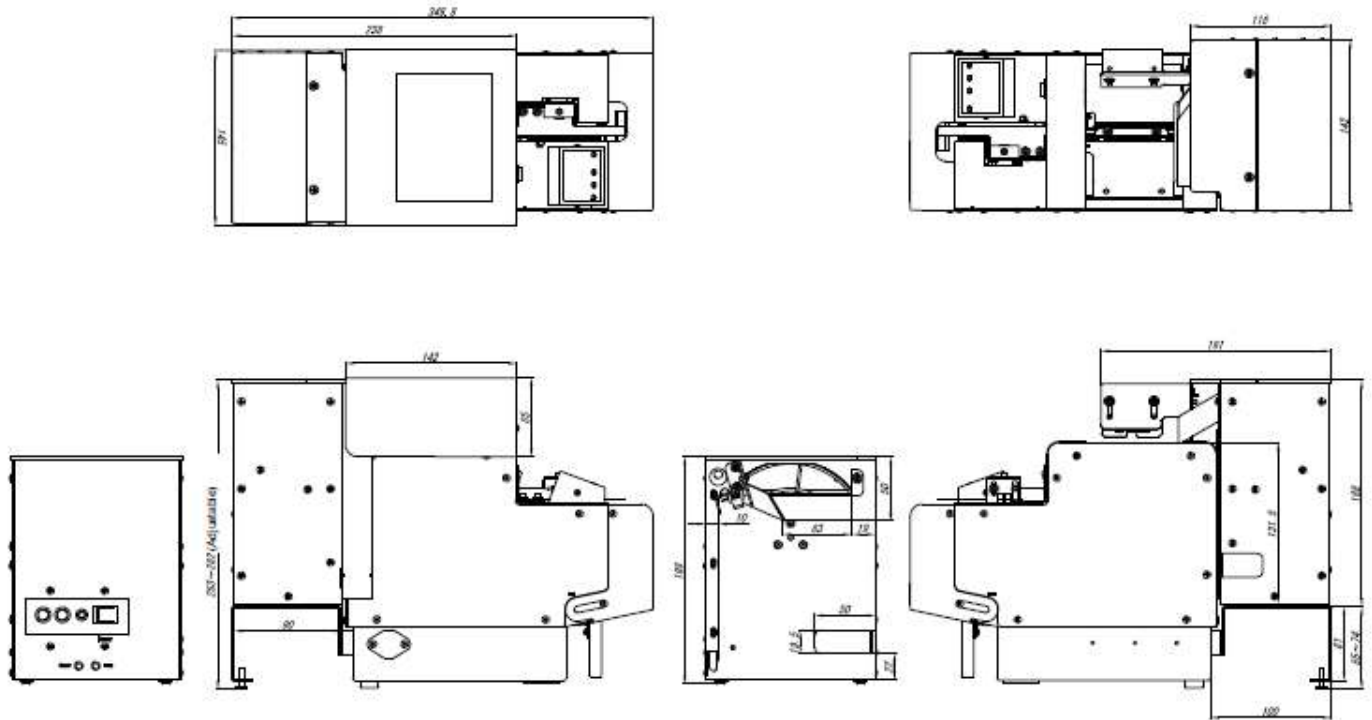

SR-80 and dispenser NSR

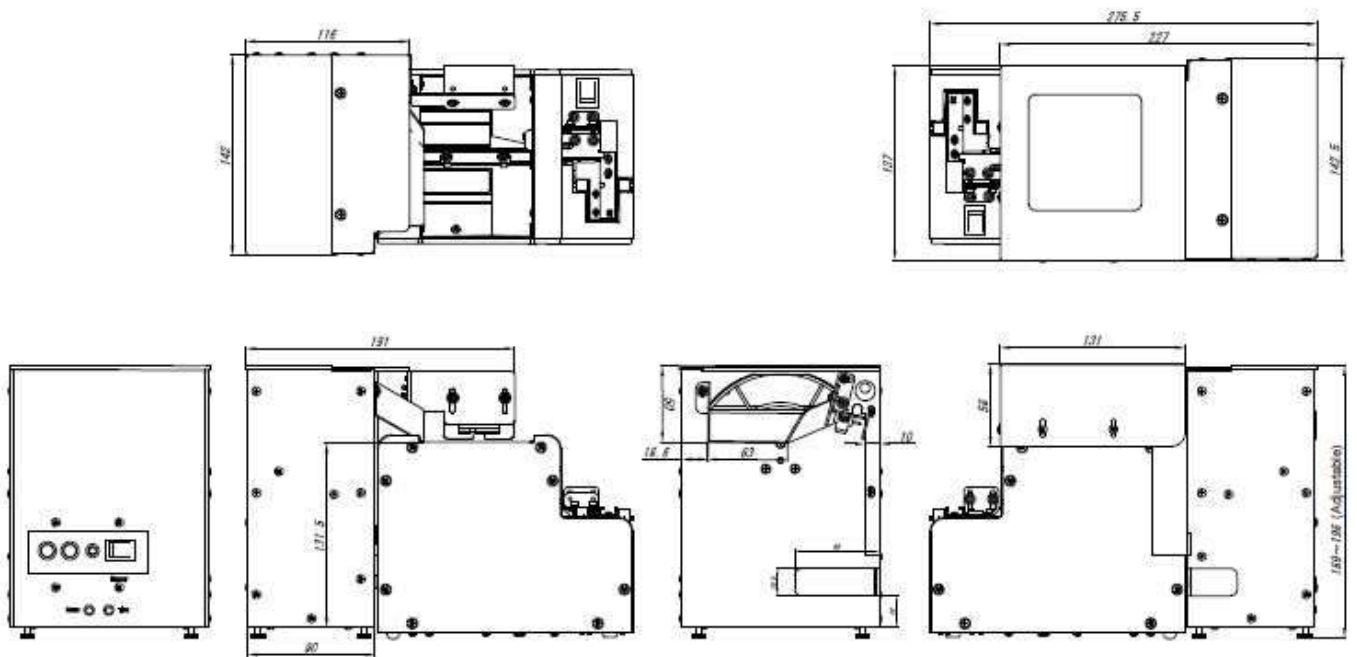

SERVICES AND ACCESSORIES

Assembly sleeve supports and guides on feeder NJR / NSR

Model	Code
Support and guide for sleeve vacuum kit Delvo	4-1525007
Support and guide for sleeve vacuum kit GX30V	4-1525032
Support and guide for sleeve vacuum kit GX40V	4-1525029
Support and guide for sleeve vacuum kit MD26	4-1525030
Support and guide for sleeve vacuum kit MD32	4-1525031

Assembly sleeve supports and guide on feeder NJR / NSR

Model	Code
Assembly package	4-1525011

Dispenser adjustment according to screw

Model	Code
Setting package *	4-1530021

** for this service a batch of 200 representative screws must be provided to us at the time of the order.*

OUR SERVICES

At DOGA we put at your disposal our reliable, accurate and user friendly tightening solutions. It is our duty to advise you of the right solution for your application.

Our Product Manager and Support engineering teams are here to analyse your manufacturing process and share with you our innovative solutions to improve your assembly process. Thanks to our technical integration service CELPRO, we provide you with turnkey solutions from design to commissioning.



TURNKEY SOLUTIONS

Using all the options of our complete product range, we offer you solutions adapted to your needs.

- ▶ Custom Design
- ▶ Adaptation of existing models
- ▶ Integration of automation system



TECHNICAL ASSISTANCE

To ensure the optimal performance and durability of our tools, we put our technical assistance at your disposal.

- ▶ Installation and start-up
- ▶ Maintenance agreement
- ▶ On-site maintenance
- ▶ Maintenance in our workshop



TRAINING

DOGA offers specialized training courses around its trades:

- ▶ Theoretical
- ▶ Technical & practical
- ▶ Audit & Consulting

RELATED PRODUCTS



Assembly tools

By combining the wide range of DOGA industrial screwdrivers and the choices we make together, we will meet your production and quality requirements.

- Torque and angle current control tools
- Torque and angle transduced control tools - STANLEY®
- Brushless electric tools



Air vacuum system & sleeves

By holding the screw under vacuum at the end of the screwdriver, this screw gripping system meets your non-magnetic or small screw assembly needs, especially when access to the screw point is restricted..

Support: www.dogatec.de

☎ +49 7361 8049950

DOGA® | ASSEMBLY TECHNOLOGY

© DOGA | DOC.60406.03/21

We constantly strive to improve our products. As a result, the dimensions and indications in this document may not always correspond to the latest production. By explicit agreement, our sales are subject to a reservation of title (the provisions of the French 05/12/1980 Act are therefore fully applicable).

📍 8, avenue Gutenberg - CS 50510
78317 Maurepas Cedex - FRANCE

www.dogatec.de